



GAS CONVERSION INSTRUCTIONS B100968

Broilmaster Gas Grills

GRILL MODEL NUMBERS

P3 P4 P3S

D3 D4

FOR CONVERSION TO NATURAL GAS

Conversion Kit Part Number BCK151

WARNING

This conversion kit is to be installed by an Empire Comfort Systems, Inc. distributor (or other qualified agency¹)* in accordance with the manufacturer's instructions and all codes and requirements of the authority having jurisdiction. Failure to follow instructions could result in serious injury or property damage. The qualified agency performing this work assumes responsibility for this conversion.

¹ National Fuel Gas Code Z223.1 (Latest Edition)

***The term "qualified agency" means any individual, firm, corporation or company which either in person or through a representative is engaged in and is responsible for (a) the installation of gas piping or (b) the connection, installation repair, or servicing of equipment, who is experienced in such work, familiar with all precautions required, and has complied with all the requirements of the authority having jurisdiction.**

PARTS LIST		
Part Description	Kit Number BCK151	Quantity Supplied
Manifold with orifice	B069003	2
Conversion Label	0	1

Important: When converting your P3/D3 and P4/D4 grill to Natural Gas, identify the valves on your new grill with the valves in the photos. This will refer you to the correct conversion instructions.

Propane grills include a conversion kit for natural gas.

Begin by removing all the components from the inside of your grill. Locate and remove the orifice hoods marked 55 mounted on the underside of the grill body. Figure 1. Use two wrenches to remove orifice hoods. Refer to Figure 2, grasp nut with first wrench and grasp orifice hood with second wrench.

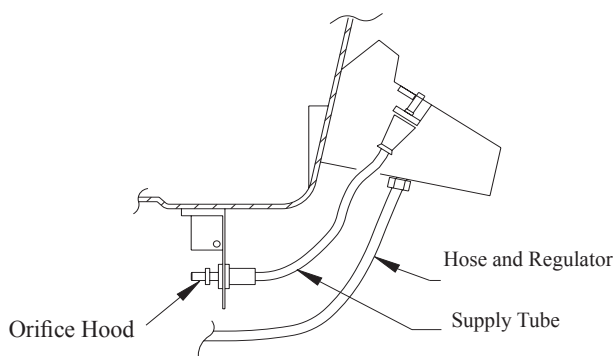

Figure 1

Before installing the natural hoods, inspect them for damage and note the number stamped on the side. The correct hood will be **marked 48**.

The hoods are self-sealing, requiring no additional pipe sealant. If you wish to use sealant, take care to add it to the threads only to avoid blocking the orifice.

Thread the hoods onto the supply tubes leaving about a 1/8" gap between the hood and the locking nut. Figure 2. Use two wrenches to install orifice hoods. Refer to Figure 2, grasp nut with first wrench and grasp orifice hood with second wrench.

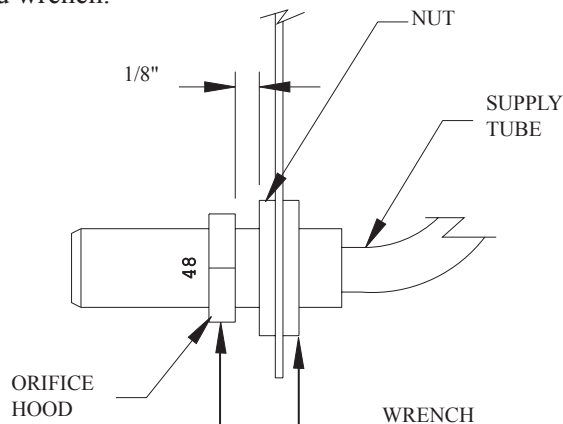

Figure 2

Remove the hose and regulator from the valve.

Replace the components inside of your grill.

MUELLER

Remove the knobs from the valve assembly and locate the adjustment screws on the inside of the valve stem. Using a small screw driver, turn the screws clockwise until screws bottom, then turn the screws four (4) FULL turns counterclockwise. Do not back the screws out more than 4 1/2 turns or a leak may result. Figure 3.

MCM VALVE

Remove the knobs from the valve assembly and locate the adjustment screws on the inside of the valve stem. Using a small screw driver, turn the screws clockwise until screw bottoms, then turn the screws two (2) FULL turns counterclockwise. Do not back the screws out more than 2 1/2 turns or a leak may result.

Connect the grill to the natural gas supply.

Important: Before lighting your grill, check the gas connections and the adjustment screws for leaks using a soapy water solution.

Caution: Never use this or any gas appliance which may be leaking gas.

Replace the knobs.

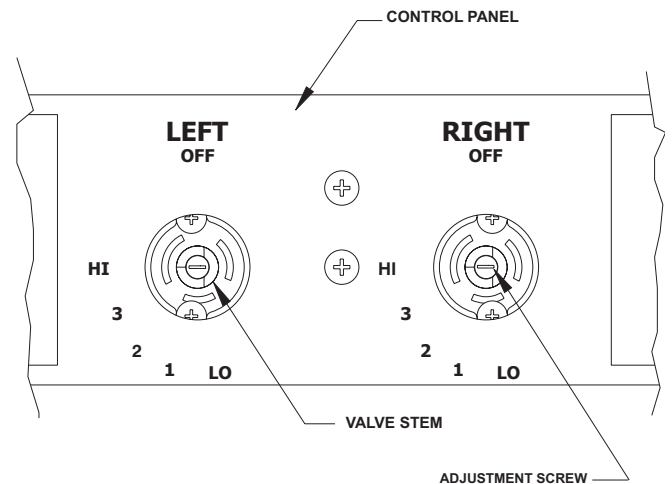
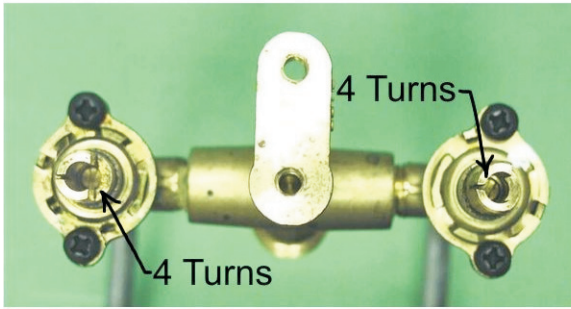

Figure 3

Place the completed conversion label adjacent to the product identification label, located on the control panel.

Note: When converting your grill to Natural gas and your incoming gas pressure is below 7", a DPA 105 regulator kit can be purchased.

Mueller Valve



MCM Valve

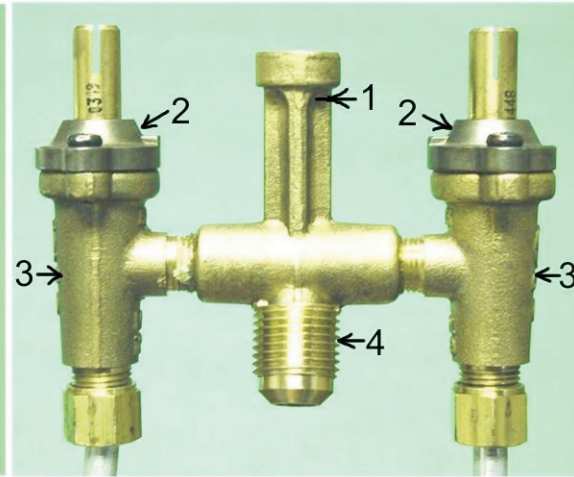
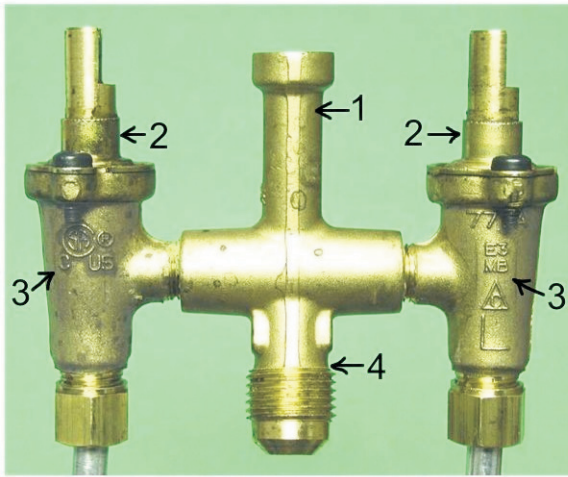
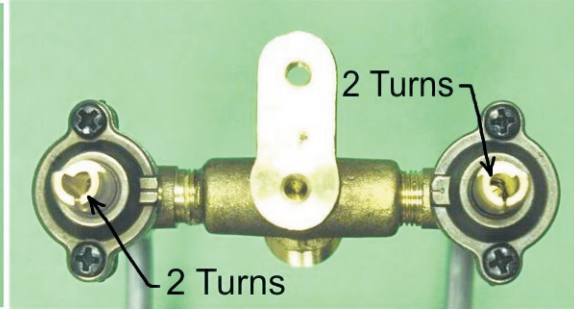

Differences between the 2 valves

1. Valve mounting flange
2. Valve stem cap
3. Stamping on exterior of valve
4. Gas inlet connection

BROILMASTER®
A Division of Empire Comfort Systems, Inc.
918 Freeburg Ave.
Belleville, Illinois 62220
Phone: 1-800-851-3153
FAX: 1-800-443-8648

VISIT OUR WEB SITE AT www.broilmaster.com